

**Moment Practice Problems**

For each situation, use  $\Sigma M_A = 0$  to determine the unknown value.

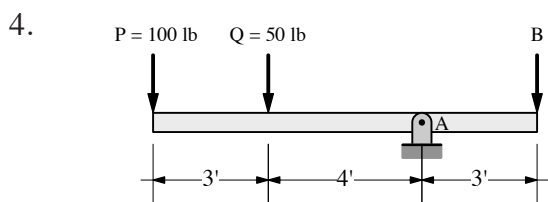

5.

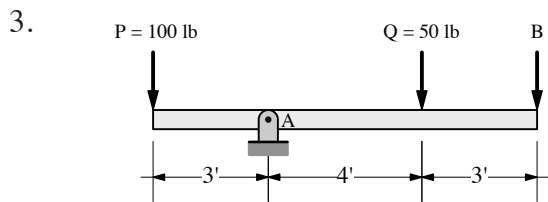
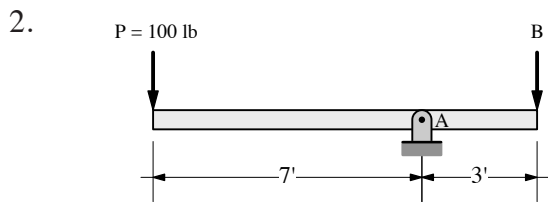
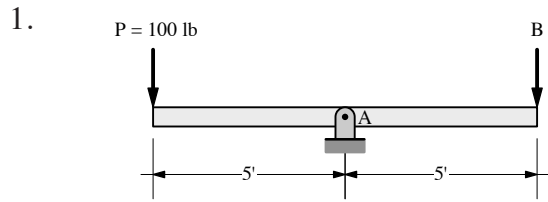
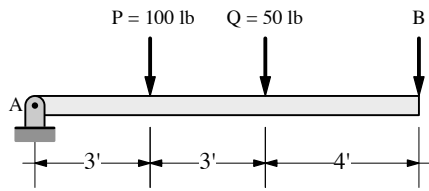

6.

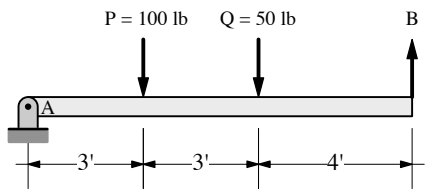

7.

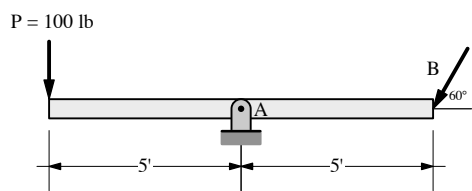

8.

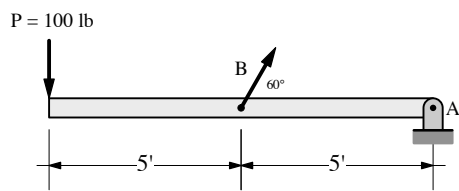

9.

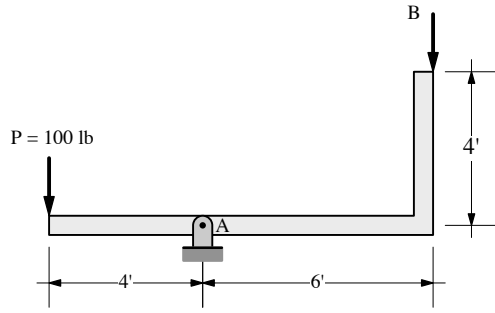

10.

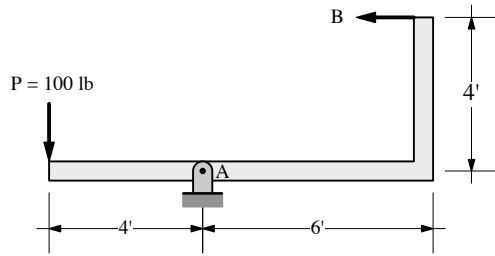

11.

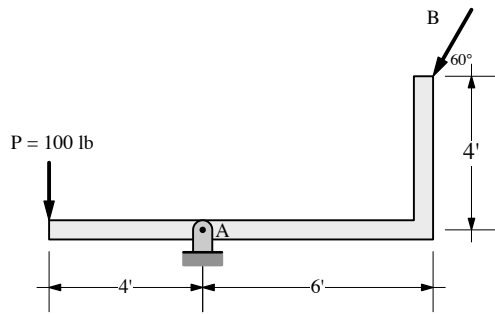

12.

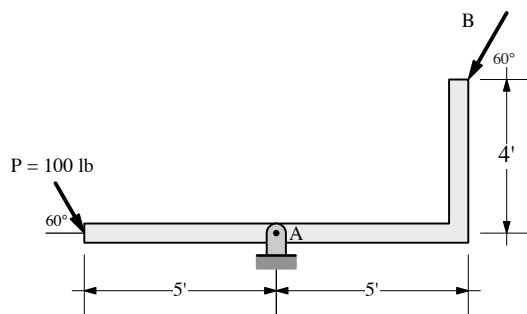

13.

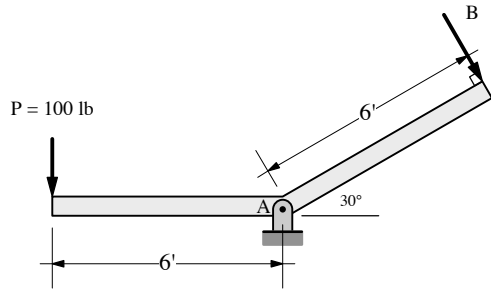

14.

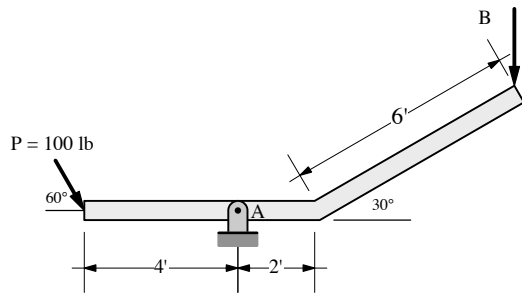

15.

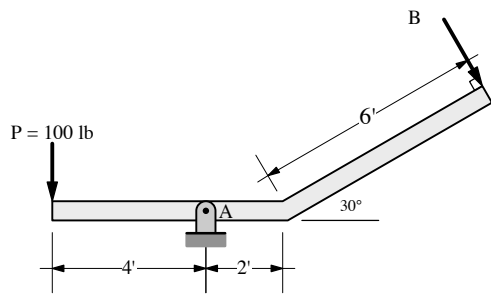

16.

